

Strictly Cellars & Accessories

"Wine Care Specialists"

12/08/2020

REDRACK STACKABLE SYSTEM

"Individual" Bottle Style

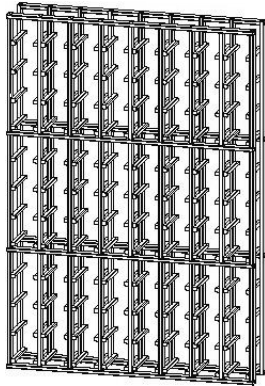

32"W x 47 3/4"H
96 Bottles
F01B \$225.00

32"W x 32"H
64 Bottles
F01A \$160.25

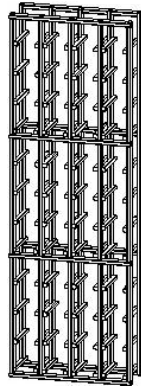

16"W x 47 3/4"H
48 Bottles
F02B \$136.65

16"W x 32"H
32 Bottles
F02A \$101.30

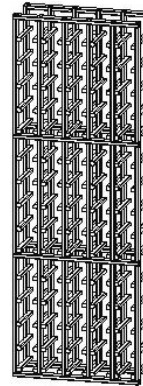

16"W x 47 3/4"H
75 (1/2 Bottles)
F03B \$160.25

16"W x 32"H
50 (1/2 Bottles)
F03A \$124.90

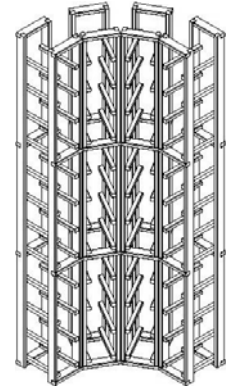

19 1/2"W x 47 3/4"H
48 Bottles
F04B \$225.00

19 1/2"W x 32"H
32 Bottles
F04A \$160.25

NOTE: Please use caution when inserting bottles into the middle two columns of the corner modules as there is no back/bottle stop, align with the adjoining bottles.

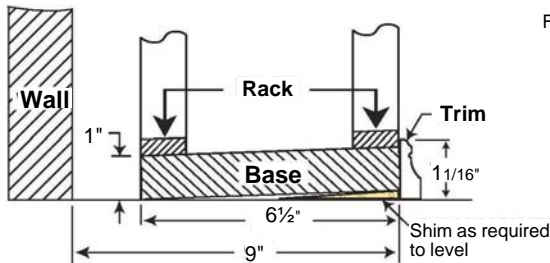

Base / Crown with Molding
F14C 1"H x 6 1/2" D x 48"W \$36.50
F14T Trim only 48" \$9.45
F15C 1"H x 6 1/2" D 32" x W \$24.75
F16C 1"H x 6 1/2" D x 16"W \$24.75 (2 Pak)
F17C Inside Corner \$54.20
F18C Outside Corner \$54.20

Flip for use as Crown molding

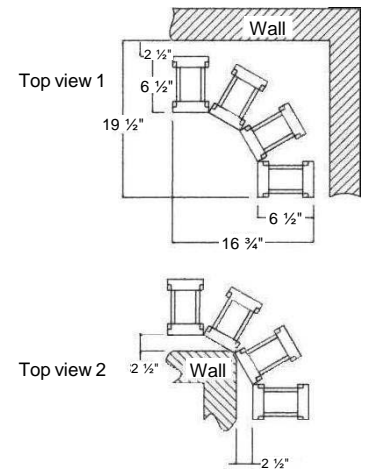
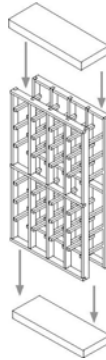

"Bin" and "Case" Styles

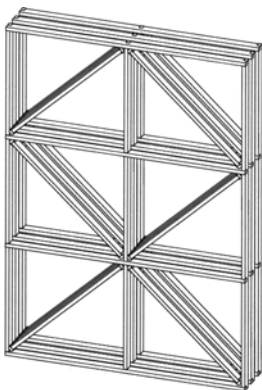

Diamond
32"W x 47 3/4"H
120 Bottles
F05B \$195.60

32"W x 32"H
80 Bottles
F05A \$154.30

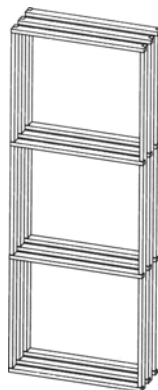

Bordeaux Bin / Card Case
16"W x 47 3/4"H
72/36 Bottles
F06B \$95.40

16"W x 32"H
48/24 Bottles
F06A \$71.85

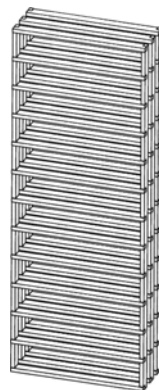

Burgundy / Bordeaux Bin
16"W x 47 3/4"H
48/60 Bottles
F07B \$136.65

16"W x 32"H
32/40 Bottles
F07A \$101.30

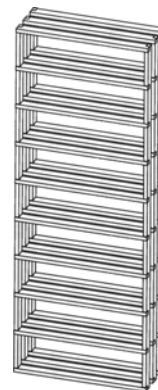

Champagne / Magnum
16"W x 47 3/4"H
36/27 Bottles
F08B \$107.20

16"W x 32"H
24/18 Bottles
F08A \$83.65

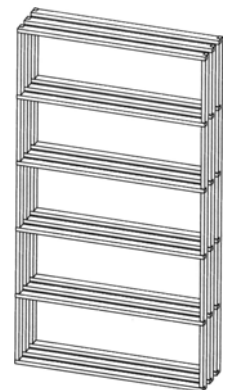

Wood Case
24"W x 47 3/4"H
60 Bottles
F09B \$107.20

24"W x 32"H
36 Bottles
F09A \$83.65

Redrack System

The ultimate in wine racking systems. Racks that look great yet costs so little you can afford to put a few more bottles in them! California redwood has that classic combination of beauty and durability, while Redrack delivers the simplest, most flexible system ever. Lightweight slim-line design, yet strong.

NOTE: Maximum capacities are based on standard Bordeaux style bottles; capacity will vary depending on style of bottle stored. Redwood is a natural material and will have small knots, grain and colour variations. Redrack may vary in machining and have minor dimensional variations between productions runs. Redrack modules ship knocked down, unassembled; assembly and installation is available in the Kelowna area. Modular wine racking is non-refundable once assembled.

Prices and specifications subject to change without notice. Prices are in Canadian Dollars, FOB Kelowna, BC

REDRACK ACCESSORIES

12/08/2020

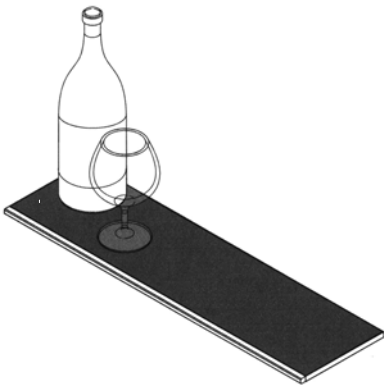
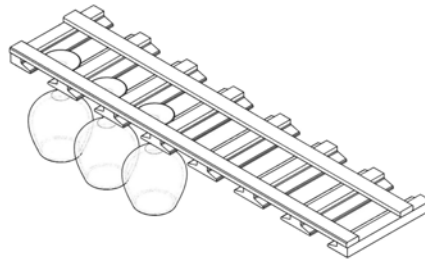
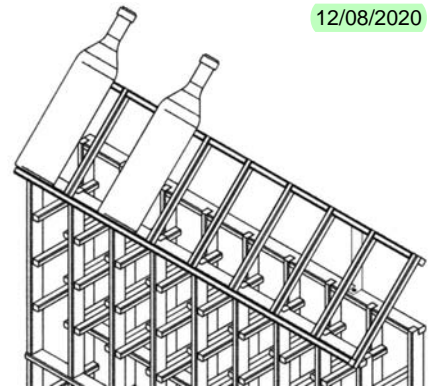

Table Top
1½"H x 9"D x 32"W
F11C \$48.30



Hanging Stemware Rack
1½"H x 8"D x 32"W
21 Glasses F13C \$101.30



Display Top
5"H x 9"D x 32"W
8 Bottles F12C \$65.95

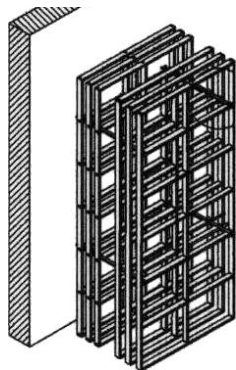

Double Depth Kit
F19C Bin/Case 21" \$34.00
F20C Individual 21" \$34.00

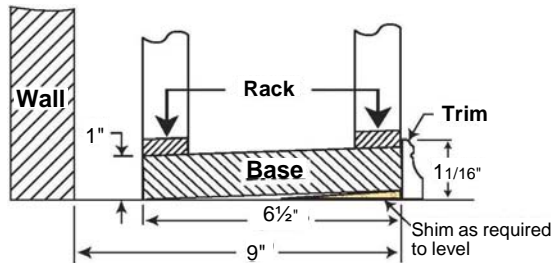

Base / Crown with Molding
F14C 1"H x 6½"D x 48"W \$36.50
F14T Trim Only 48" \$9.45
F15C 1"H x 6½"D 32" x W \$24.75
F16C 1"H x 6½"D x 16"W \$24.75 (2 Pak)
F17C Inside Corner \$54.20
F18C Outside Corner \$54.20
F21C Cove Molding (4 x 48") \$48.30
F22C Extra Brackets \$4.75 (2 Pak)
F23C Molding End Cap \$12.95 (2 Pak)

Flip for use as Crown molding

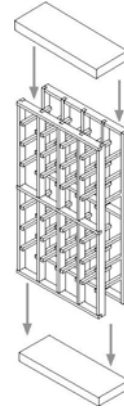

Stackable Modularized System

Stackable (32" and 48"H) Redrack System gives you a new dimension of freedom, with our fully modular "Stackable" system. It's never been easier to go Full wall height where you want to, or half wall height where you need. Mix and match to your heart's content with our nine basic rack styles, in standard widths and height. Brackets and fasteners included. Depth of racks and base / molding kits are measured from front of rack to wall. Actual redwood depth is 6 ½" with 2 ½" free space between the back of the rack and the wall.

Perfectly modular in order to accommodate heights other than 6' and 8'.

The stackable system is available in two heights, A (32") and B (48") allowing for the following modularity with 5 choices in height.

• Base / Crown molding can be added to any configuration. (allowance is provided for shimming the base for leveling)

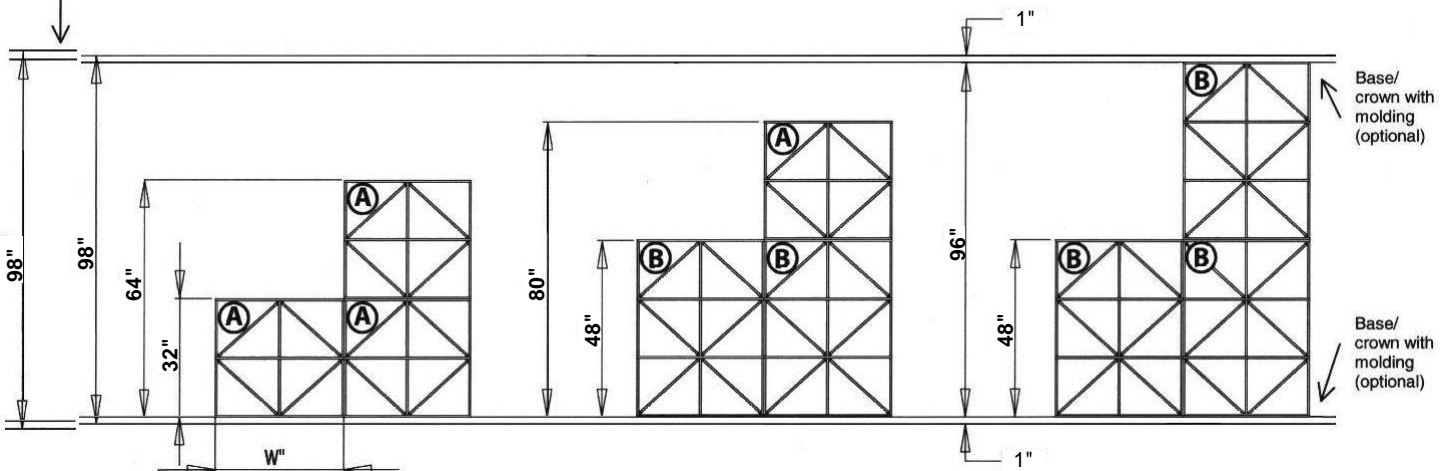

1873 Spall Road, Suite 5, Kelowna, BC V1Y 4R2
Tel: 250-448-7225 Toll Free: 1-866-396-7225 Email: inquire@strictlycellars.com
Website: www.strictlycellars.com

Note: Redrack modules ship knocked down, unassembled; assembly and installation is available in the Kelowna area. Non-refundable once assembled. Prices and specifications subject to change without notice. Prices are in Canadian Dollars, FOB Kelowna, BC